

Auragami RGBW Instruction Manual

Specification code: AP-AURA-RGBW



CONTENTS

Each AuragamiLight Sheet package includes one sheet (A), two short wires (B), two long wires (C) and eight bumpers (D).

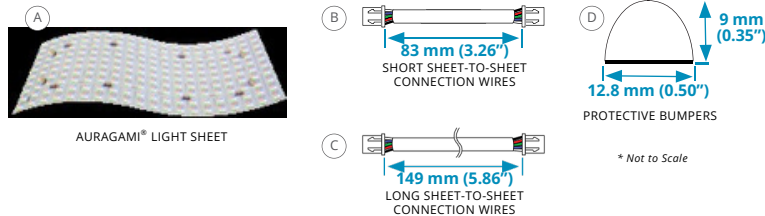

PART	DESCRIPTION	QTY
A	Auragami® Light Sheet (19.80" x 9.25" / 503.5 mm x 235 mm) with 3M® adhesive backing and 12 integrated connection blocks	1
PART	ACCESSORY PACK (INCLUDED: AG1-24-SCW-AP)	QTY
B	20 AWG short sheet-to-sheet connection wires 3.26" (83 mm)	2
C	20 AWG long sheet-to-sheet connection wires 5.86" (149 mm)	2
D	Protective bumpers with silicone adhesive backing	8

BEST PRACTICES



Do not set anything on top of Light Sheets (i.e. tools, mugs, etc.). Do not set Light Sheets on the floor where they could be stepped upon or where anything can be dragged or set upon them. Light Sheets can be damaged unless properly handled.



Due to possible unforeseen issues with shipping and handling, we advise that all Light Sheets be inspected at time of delivery and dry-fit tested for proper illumination prior to mounting and again before the forward facing material is installed.

For troubleshooting guidance, please visit www.evo-lite.com/troubleshooting

PROFILES

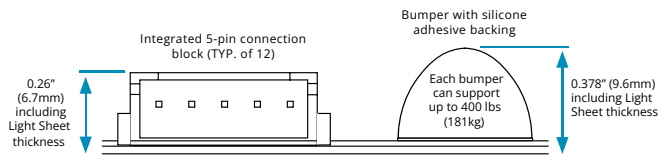

SAFETY & COMPLIANCE INFORMATION Read all instructions before beginning.

- // **WARNING: RISK OF ELECTRIC SHOCK.** Disconnect power at the source before snapping, cutting, or altering product in any way. Do not connect product to AC current. Use only with 24VDC input power.
- // To reduce the risk of fire, electric shock, or injury to persons, pay close attention to this manual and stay within its guidelines when using this product. Save these instructions for future reference. Read and follow the product handling, installation, & integration advisory on page 4. Disconnect power at the source before cutting or altering the light sheet(s) in any way. Do not connect light sheets to AC current. Use only with 24VDC input power.
- // Product should be installed in accordance with local/regional electrical codes and the current National Electric Code (NEC).
- // Product must be installed per instructions and contained within and exclusive to application where not subject to damage.
- // Use only with UL Listed or UL Recognized Class 2, Limited Power Source (LPS) or Low Voltage Limited Energy (LVLE) power supplies. Provide the appropriate number of 24V Class 2 circuits for your layout. Do not exceed the maximum load limit of any power supply per the manufacturer's recommendations.
- // To retain Class 2 compliance per UL regulations, do not interconnect more than eight full Light Sheets (88 watts total) in any configuration. Each Light Sheet consumes 11 watts of power (0.46 A at 24VDC). In order to connect eight Light Sheets, confirm that the combined power consumption is never more than 88 watts total. The Light Sheet's FPC (Flexible Printed Circuit) design and integrated connection blocks have a 96 W / 4 A at 24VDC capacity. Do not exceed the capacity of the FPC and connections blocks in any configuration.
- // This product is rated IP65 and can be used in wet locations, but not where water may accumulate. Refer to wet location advisory on back page.
- // When using any type of mechanical fastener, make sure the fastener head does not penetrate the Auragami Light Sheet. Any penetrations of the Light Sheet must be made inside the smaller of the two concentric circles marked on the sheet.

BEST PRACTICES

- // LEDs are bright. Do not look directly at lighted sheet.
- // To avoid visible brightness variances due to voltage drop, the total distance from power source input to the farthest end of any interconnected sheet should not exceed 6.5 feet (2 meters). See power input section on page 3.
- // Dry fit the Light Sheets and their connection wires before installing them permanently to a substrate. Always test operation before installing the translucent (forward facing) material.
- // Horizontal applications require a completely flat mounting surface. Any deviations could result in the forward facing material(s) being damaged.
- // Never slide heavy material over the bumpers, this can cause damage to the Light Sheet. If a forward facing material needs to be removed, lift the material, do not drag as this can damage the Light Sheet.
- // Do not fold Light Sheets back-to-back.
- // Avoid installing where subject to continuous flexing.
- // Application specific installation guides are available upon request.

ELECTRICAL	
Input Voltage	24 Volt DC - Constant Voltage
Input Power	11 watts per sheet
Connectivity	Up to eight sheets via integrated connection blocks (not to exceed 88 W)
Certification	UL Listed (E495221), CE Compliant (EMC and LVD), RoHS Certified, IP65
PHYSICAL	
Cut/Fold Line Spacing	0.99" (25.18 mm) short axis / 0.925" (23.5 mm) long axis
Coverage	1.27 ft ² (0.118 m ²) per sheet / up to 10.18 ft ² (0.94 m ²) per Class 2 guidelines
Operating Temp.	-30°C (-22°F) ~ +50 °C (+122 °F)
POWER & CONTROLS	

Compatible with full range (100% - 0%), flicker-free power and control components. Please contact Evo-Lite for optimal solutions to fit your requirements.

Discuss your project with our Applelec Projects team:
appleleccompany.com | projects@applelec.com | 01274 77 44 77

Auragami Single Colour White Instruction Manual

Specification code: AP-AURA-TW



AURAGAMI® DRY FITTING, CUTTING* AND FOLDING

Dry fit the sheets and connection wires before mounting the Light Sheets to the substrate. **Always test function before installing the translucent (forward facing) material.**

To make a fold in an Auragami Light Sheet, bend the sheet along one of the dotted lines marked on the sheet, then crease along this line, then relax the fold into a 90° (or other desired) angle. **Be careful about folding where an LED is attached to the sheet since LEDs can break if forced over an edge. Do not repeatedly fold and unfold along the same line as this will weaken the flexible PCB. Do not fold a Light Sheet back onto itself, however two separate Light Sheets can be attached back-to-back.**

To make a cut in an Auragami Light Sheet, use shears, scissors, a utility knife and/or a precision/craft knife. Use a sharp tool to create a clean edge and precise cuts. Cut on horizontal, vertical and/or diagonal lines. Deviating from the lines could cut off power to one or more LEDs. **If a cut edge has the possibility of making contact with a conductive surface or another cut edge, cover the cut edge with RTV sealant or conformal coating.** If one or more connection blocks exist on a cut/fold line, it is best to remove the connection block* to make a clean fold or cut. Using a pair of slip-joint pliers, grasp the connection block firmly (front side to back as illustrated at right) and rotate it either clockwise or counterclockwise while holding the Light Sheet in place. The connection block will unseat from the solder. Repeat for other connection blocks as needed and discard the removed block(s).

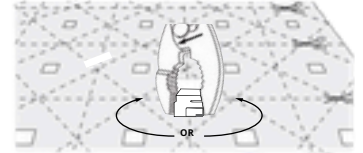

***NEVER CUT OR ALTER LIGHT SHEET(S) WHILE POWERED.**

USING AURAGAMI® ACCESSORIES

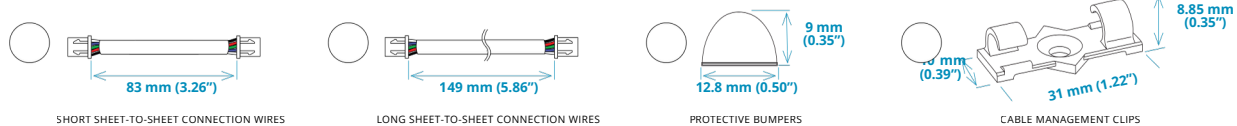

Short sheet-to-sheet connectors (B): When adjacent Auragami Light Sheets are mounted side-by-side with connection blocks aligned, the shorter sheet-to-sheet connection wires (B) should be used to interconnect multiple sheets. Their lengths are optimized so sheets align snugly. See Figure 1. When connecting Light Sheets that are already mounted to a fixed surface, the short connection wires (B) will need to be shaped as shown in Figure 2 prior to pushing into connection blocks. Best practices include using two sheet-to-sheet mounting connection wires for all adjacent Light Sheets in each Class 2 circuit to minimize voltage drop. Dry-fit test for proper illumination prior to mounting Light Sheets to the mounting surface and again before the forward facing material is installed.

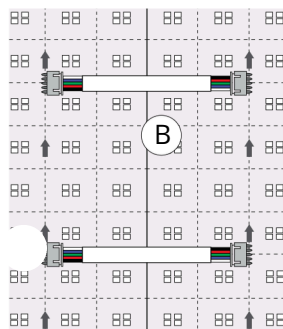

Figure 1

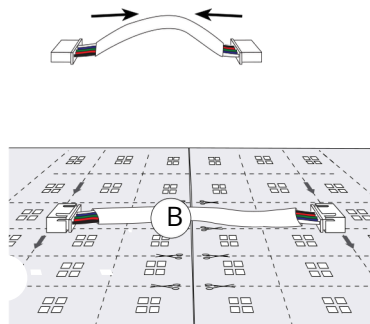

Figure 2

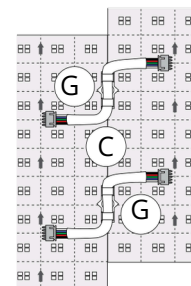

Figure 3

Long sheet-to-sheet connectors (C):

Use the long sheet-to-sheet connection wires (C) to bridge gaps and/or connect offset sheets as shown in Figure 3.

Domed protective bumpers (D):

Rated for 400 lbs each, the domed protective bumpers (D) included with each Light Sheet have been engineered to bear the weight of translucent materials in horizontal applications and act as a safeguard in vertical applications so that the forward facing material does not harm the Light Sheet's integrated connection blocks or LEDs. Evo-Lite recommends using eight bumpers per Light Sheet (approximately six per square foot), spacing them evenly to distribute the weight of the forward facing material (see Figure 4) and to add a level of protection in vertical applications when the forward facing material will be positioned near the Light Sheet (see Figure 5). A rigid, non-deforming mounting surface/substrate must be used with any weight bearing applications to avoid damaging the Auragami Light Sheet.

Cable management clips (G) (included in the power input kit sold separately):

Route the connection wires so that the light from the LEDs is not blocked and hold the wires in this position using cable management clips with silicone adhesive backing (G) as shown in Figure 3. Once applied, let this adhesive backing cure for 10-30 minutes before routing wires through the clip. When possible, use a mechanical fastener to secure the clip. If this is not possible in your installation you may need to utilize a cyanoacrylate adhesive to create a reliable bond between the clip and light sheet. A supplementary document that outlines this process is available upon request.

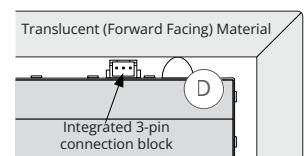

Figure 4

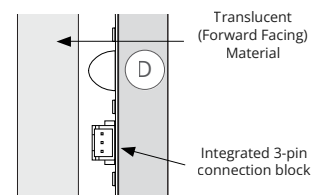

Figure 5

Discuss your project with our Applelec Projects team:
applelecprojects.co.uk | projects@applelec.co.uk | 01274 77 44 77

POWER INPUT

Use only with Class 2 power units. To avoid visible brightness variances due to voltage drop, the total distance should not exceed 6.5 ft (2 meters) from the Light Sheet's power supply input to the farthest end of any interconnected sheet. If this distance exceeds 6.5 ft (2 meters), splice an additional high count multi-strand lead wire (that is the appropriate gauge for the load and distance) to the power input wire and connect this lead to a sheet that is centrally located within the interconnected sheets. Alternatively, split the length in two and power each with its own power supply, making sure the two sections are not connected electrically (see Figure 6).

One power input is required for each Class 2 circuit

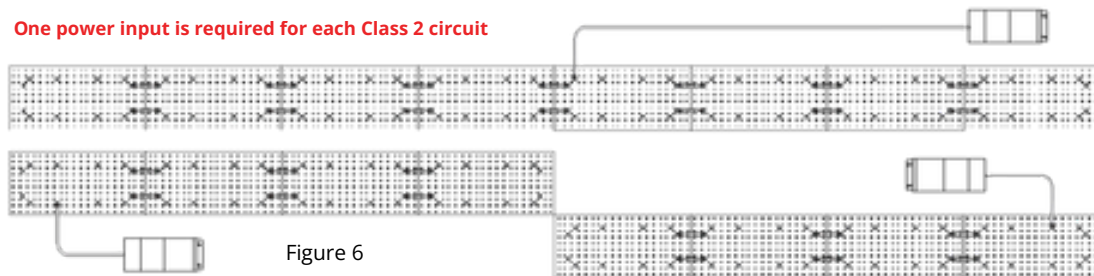

Figure 6

Power Input Kit, SKU: AG1-24-RGBW-PIK (sold separately):

Includes one 48" (1219.2 mm) 20 AWG 5-conductor power lead wire with stripped & tinned ends (E), five Wago connectors (F) (see Figure 7) and four cable management clips (G) (see Figure 3).

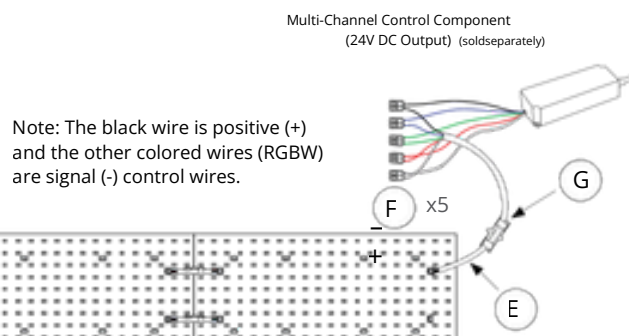
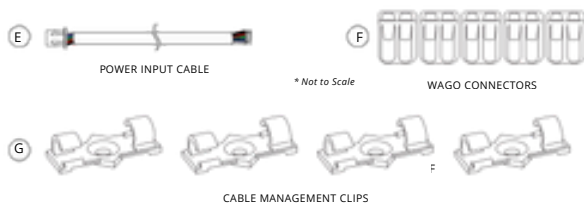

Figure 7

Use the power lead (E) to route power from the power supply to a single Light Sheet or a set of up to eight Light Sheets. Use Wago connectors (F) in place of wire nuts, for a secure connection of wires of the same polarity (see figure 7). Do not exceed the 4 A maximum load capacity of a connection block in any configuration nor interconnect more than eight sheets (88 W total). If any Light Sheet fails to light, check that the sheet-to-sheet connection wires are fully connected into the 5-pin connection blocks. If the whole layout fails to light, check polarity at the power supply, proper connection at the splicing connectors, and supply power at the source.

Light Sheets are dimmable, compatible with full-range (100% - 0%), flicker-free power and control components. Barrel connectivity options/accessories are sold separately for use with barrel connected plug-in power supplies. Contact an Evo-Lite Systems Integration Specialist for optimal power and control solutions to fit the project needs.

LIGHT SHEET ORIENTATION

RGBW and Tuneable White Auragami Light Sheets have arrows printed on them. These arrows mark the direction and orientation that all sheets must be installed. **When mounting multiple sheets, it is important that the arrows on each sheet line up and point the same direction.** These arrows help maintain equal LED spacing. If the arrows are not aligned, you may experience color shifts or hot spots. See Figure 8.



Figure 8

MOUNTING LIGHT SHEETS

Various mounting methods may be used to secure the Light Sheets to the mounting surface after the dry-fit and operation tests are complete. Use the appropriate method or combination of methods depending on the type of mounting surface and its orientation. Mechanical fastening is recommended in addition to the adhesive back.

Mechanical Fasteners: Any penetrations through the Light Sheet must be made inside the concentric circles marked on the sheet. The smaller diameter circle on the Light Sheet indicates the maximum diameter of screw or other fastener that can be used without causing damage to the Light Sheet's power distribution grid. The larger diameter circle is the maximum diameter of the screw head that can be used without causing damage. See Figure 9. For suspended applications, use mechanical fasteners with an appropriate spacing to avoid sagging. Use pan head, domed, or round head screws – not tapered screws (like wood or drywall screws) nor self-tapping screws – and never screw the fastener so much that it deforms the Light Sheet. See Figure 10. **Re-test function before installing the translucent (forward facing) material.**



Figure 9



Figure 10

Auragami Instruction Manual Single Colour White

Specification code: AP-AURA-TW



PRODUCT HANDLING, INSTALLATION & INTEGRATION ADVISORY

Evo-Lite's experience in providing backlighting solutions yields a unique perspective on the characteristics and underlying intuitive knowledge necessary to complete a successful installation of Auragami. Evo-Lite is committed to educating and supporting all our customers so every installation proceeds as smoothly as possible. Most installations offer their own unique challenges; we hope by making you aware of the following handling and installation guidelines you are empowered with knowledge for a successful installation. As always, your Evo-Lite Systems Integration Specialist or any of our staff are ready to assist you with any questions that arise during your installation.



TEST BEFORE INSTALLING

Our production, packaging and shipping process is accompanied by a rigorous quality control procedure. All Auragami Light Sheets are subjected to a burn in period and are tested before packaging to ensure operation of the highest quality. Due to possible unforeseen issues with shipping and handling, we advise that all Light Sheets be inspected at time of delivery and dry-fit tested for proper illumination prior to mounting and again before the forward facing material is installed.



DO NOT CONNECT TO AC POWER

ANY DIRECT CONNECTION OF AURAGAMI LIGHT SHEETS TO AC CURRENT WILL DAMAGE THE LEDs. Be sure to use a UL Listed or UL Recognized Class 2, LPS or LVLE low voltage power supply that conforms to the voltage requirements of the Light Sheet. This information can be found on the Auragami Light Sheet and its packaging, as well as the power supply labeling.



POWER, CONTROL, & WIRING

For optimal power distribution and to minimize voltage drop, it is recommended that multi-strand, high strand count wiring be used for all low voltage DC connections. Wire gauge should be appropriate based upon system voltage and wire lengths to further minimize voltage drop. Power supplies, drivers and controls should be installed in well ventilated enclosures and/or per manufacturers recommendations. It is the customer's responsibility to ensure all components and installation practices meet or exceed local codes and requirements.



FRAGILE CONNECTION BLOCKS

DISCONNECT POWER AT THE SOURCE BEFORE REMOVING ANY CONNECTION BLOCKS. The Light Sheet's integrated connection blocks are made of plastic which can be damaged if made to bear weight. Use domed protective bumpers (included) to bear the weight of any forward facing material in horizontal applications and to act as a safeguard to protect the Light Sheet in vertical applications.



CUTTING

DISCONNECT POWER AT THE SOURCE BEFORE ALTERING THE SHEET IN ANY WAY. NEVER CUT AURAGAMI LIGHT SHEET WHILE POWERED. Field cutting of the Light Sheet does not void UL Listing. LEDs can lose input power if cut lines are not followed. Use a sharp tool to create a clean edge and precise cuts. Avoid cut edge contact with any conductive material(s), including other cut edges of Light Sheets. See also Wet Location Use below.



DRILLING

DISCONNECT POWER AT THE SOURCE BEFORE ALTERING THE SHEET IN ANY WAY. Light Sheets have specific areas where holes can be made in the sheet. The smaller diameter circles on the Light Sheet (0.12" / 3 mm) indicate the maximum diameter of screw or other fastener's shaft that can be used without causing damage to the Light Sheet's power distribution grid. The larger diameter circle (0.28" / 7 mm) is the maximum diameter of the screw head that can be used without causing damage.



FASTENING

USE PAN HEAD, DOMED, OR ROUND HEAD FASTENERS, NOT TAPERED SCREWS. Never screw the fastener so much that it deforms the Light Sheet. Only penetrate the Light Sheet within the smallest of the two concentric circles marked on the sheet (see Drilling above for screw size limitations). For suspended applications, use mechanical fasteners with an appropriate spacing to avoid sagging.



INSTALLATION TEMPERATURE

Due to the characteristics of the 3M adhesive backing, installation environments and locations should be taken into consideration. Low temperatures can cause longer cure times for permanent adhesion.



FOLDING & MINIMUM RADIUS

There is no minimum bending radius for Auragami Light Sheets, however a single sheet may not be folded on itself because this could disrupt the flow of electricity through the folded sheet. Two separate IP65 sheets may be attached back-to-back since the 3M adhesive backing will act as non-conductive barrier. Light Sheets are not recommended for applications where a radius of less than 2" exists.



STORAGE

Store Auragami Light Sheets in a clean, dry area on a flat, horizontal surface. Do not open the anti-static envelope until ready to install. Ideal storage conditions: Temperature of 68° - 77° F, 50% humidity.



SOLDERING

DISCONNECT POWER AT THE SOURCE BEFORE ALTERING THE SHEET IN ANY WAY.

Due to Auragami's ability to be cut into unique shapes and to maximize the possibilities, the Auragami sheets have been engineered with + and - solder pads. These can be used for interconnecting individual pieces and power input cables when sheet connection block terminals have been removed or positioning is not applicable. The solder pads are engineered for no more than 4A at 24VDC. We recommend lead-free, flux-core solder. Before soldering, carefully scratch away the thin conformal coating with a precision cutting tool and avoid damaging the copper solder pad. Follow electronics soldering best practices.



WET LOCATION USE

Auragami Light Sheets are IP65 rated per the standardized International Protection Code testing and rating system. An IP65 rating means this product is protected against dust ingress and temporary jets of water. This does not mean that Auragami is waterproof. Auragami should never be continuously and/or frequently exposed to water or to conditions where moisture could pool on the light sheet or in the connector blocks and not evaporate quickly. When Auragami is used in wet or damp conditions it should be encased by the material it is illuminating or by a full or partial framed enclosure.

It is essential to understand that the protection testing is performed in a controlled environment and does not necessarily reflect real-world conditions or scenarios over extended periods of use.

If Evo-Lite understands that your application may be subjected to higher moisture levels than what the IP65 protection implies, but not to the point of over saturation or misuse, we will require that additional protective measures be employed when installing Auragami in locations subject to continuous and/or frequent moisture. Application of acid-free, electronic grade silicone to the product's connection terminals and cut edges in these scenarios will be required. Failure to adequately protect these areas may result in electrolytic corrosion that affects the product's functionality.

Failure to identify these conditions to Evo-Lite and/or failure to adequately protect the light sheet in these conditions will negate the product's warranty. Additional instructions for fortifying Auragami against these scenarios are available at www.evo-lite.com or from your systems integration specialist.



Auragami® is a patented product of Evo-Lite, LLC.

Discuss your project with our Applelec Projects team:
applelecprojects.co.uk | projects@applelec.co.uk | 01274 77 44 77